



Milan

ART. NR.7850026



Swing King

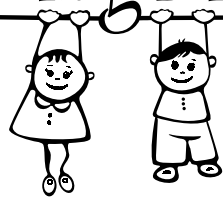

Milan

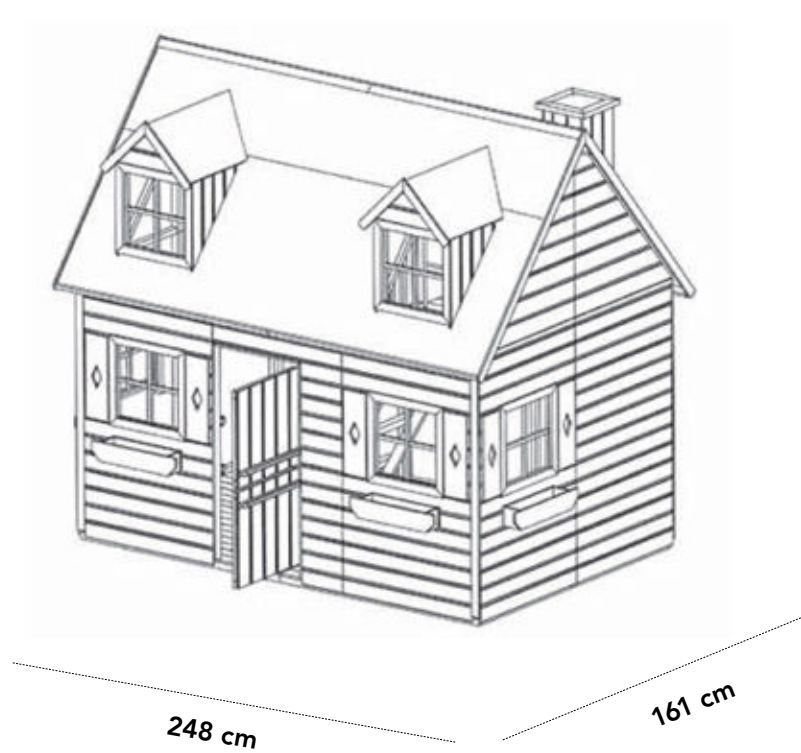
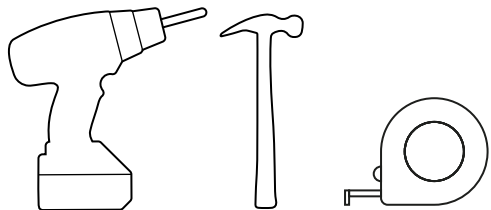

251 cm

248 cm

161 cm

Omschrijving	Nr.	Onderdeel	Maat in mm	Hoeveelheid
Vloerdeel binnen	1	Voorgemonteerd paneel	795x1230	4
Voorwand	2	Voorgemonteerd paneel	795x1380	5
Voorwand met raam gat	3	Voorgemonteerd paneel	795x1380	4
Wand met deur gat	4	Voorgemonteerd paneel	795x1380	1
Voorwand links	5	Voorgemonteerd paneel	805x950	2
Voorwand recht	6	Voorgemonteerd paneel	805x950	2
Verdiepingsvloer	7	Voorgemonteerd paneel	1050x760	2
Hekwerk (groot)	8		755x1140	1
Hekwerk (klein)	9		194x1140	1
Dakkapel -D	10	Voorgemonteerd	490x410	2
Dakkapel -G	11	Voorgemonteerd	490x410	2
Dakkapel voorwand	12	Voorgemonteerd paneel	235x470	2
Deur	13	Voorgemonteerd paneel	507x500	2
Dakligger	14	Lat 27x35	L1230mm	12
Dakligger	15	Lat 27x35	L500mm	6
Dakbeschoot	16	Voorgemonteerd paneel	1350x300	4
Dakbeschoot	17	Voorgemonteerd paneel	460x412	2
Dakbeschoot	18	Voorgemonteerd paneel	240x412	2
Dakbeschoot	19	Voorgemonteerd paneel	1350x592	4
Dakbeschoot	20	Voorgemonteerd paneel	1350x412	2
Dakbeschoot dakkapel -D	21	Voorgemonteerd paneel	675x360	2
Dakbeschoot dakkapel -G	22	Lat 12x47	675x360	2

Afwerklat	23	Lat 12x47	L1350mm	4
Dak afwerkingslat	24	Lat 12x47	L1304mm	8
Deur afwerklat	25	Lat 12x47	L1120mm	2
Deur afwerklat	26	Lat 12x47	L540mm	1
Raamkozijn	27	Assemble strip	470x470	6
Kozijnlatten	28	Lat 18x18	415x415	6
Plexiglas	29	Plexi	415x415	6
Boeiboord	30	Lat 12x47	L1400	4
Boord dakkapel	31	Lat 12x47	L400	4
Bloembak	32			4
Trap	33	Lat 27x55	L1335	2
Traptreden	33	Lat 27x55	L500	4
Dakkapel zijpaneel -D	34	Voorgemonteerd paneel	250x550	1
Dakkapel zijpaneel -g	35	Voorgemonteerd paneel	250x550	1
Dakkapel voorpaneel	36	Voorgemonteerd paneel	225x250	1
Achterzijde dakkapel	37	Voorgemonteerd paneel	225x530	1
Dakkapel afwerklat	38		20x35	4
Deur afwerklat	39	Profile	L500mm	
Dakbedekking	40	Bituminous	2,6mx1m 740x680 250x250	
Scharnier	41		L500mm	
Magneet	42			
Raamkozijn pannel	43		L470x80	
Montage set				

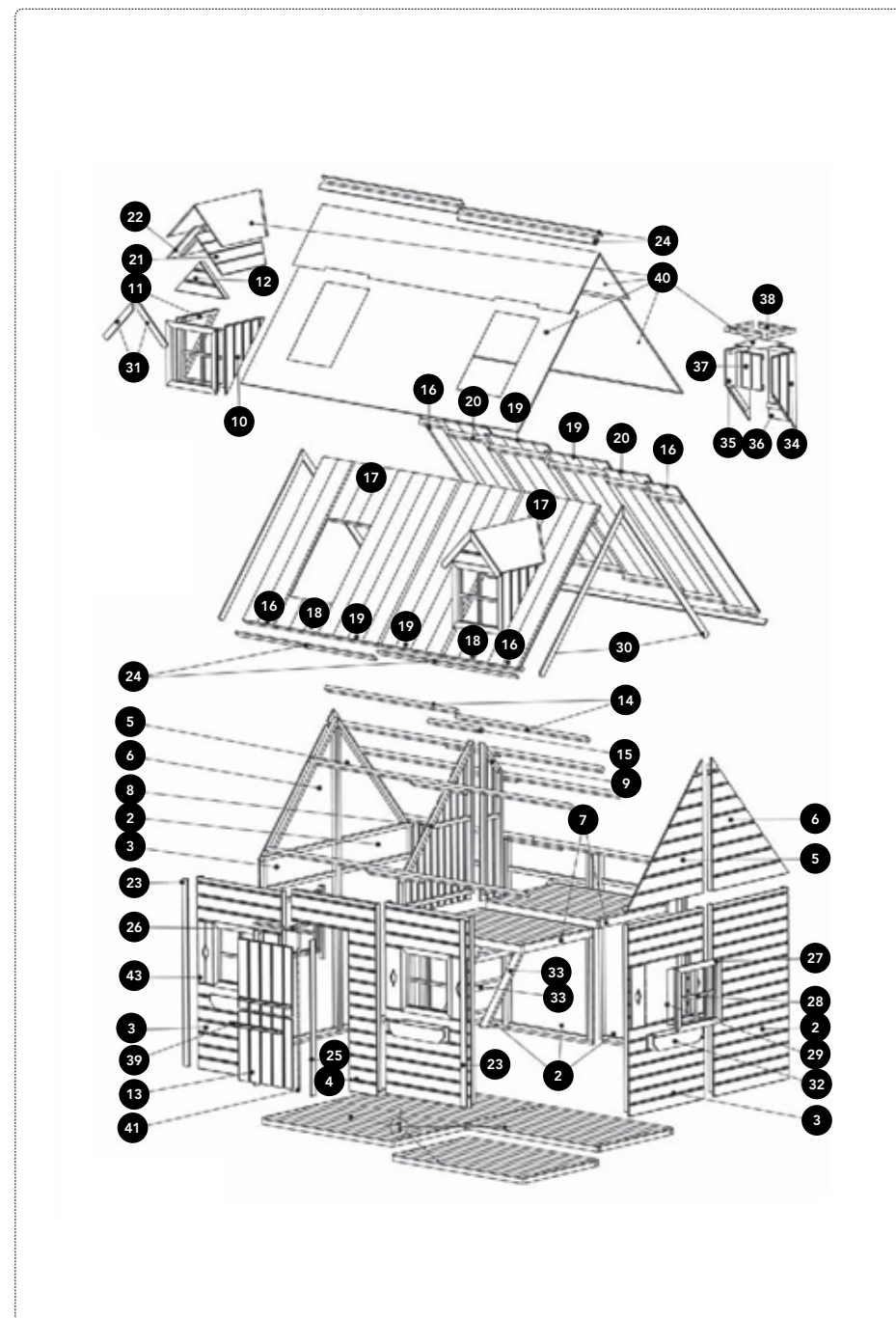

1

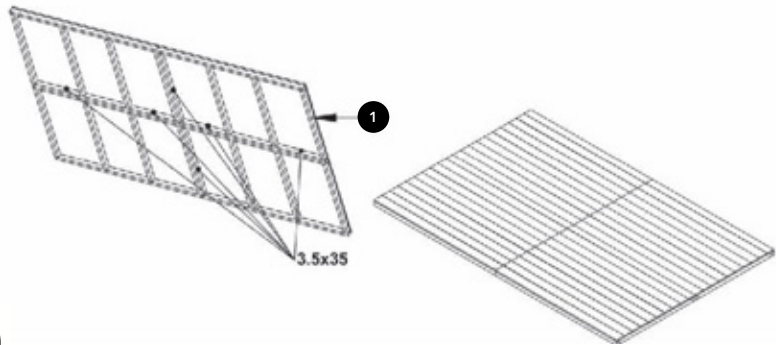

2

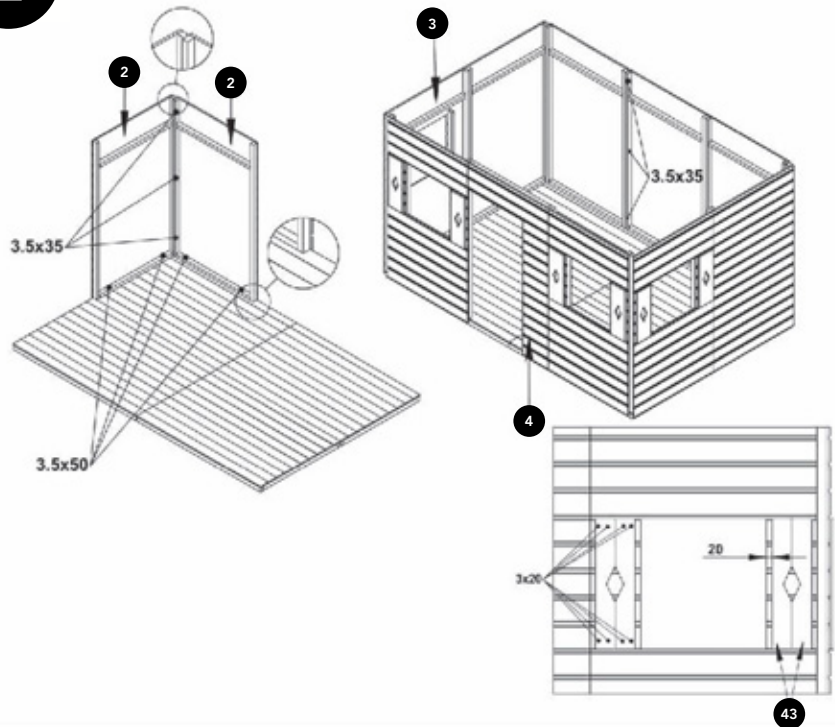

3

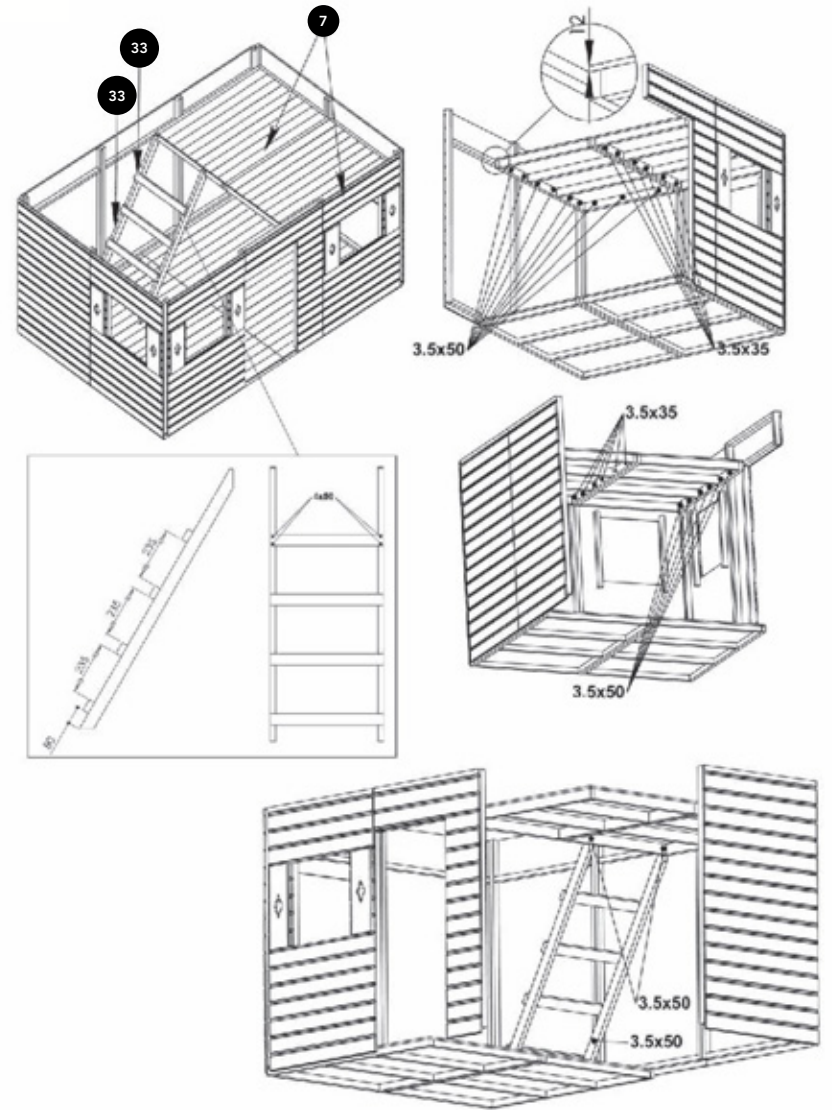

7

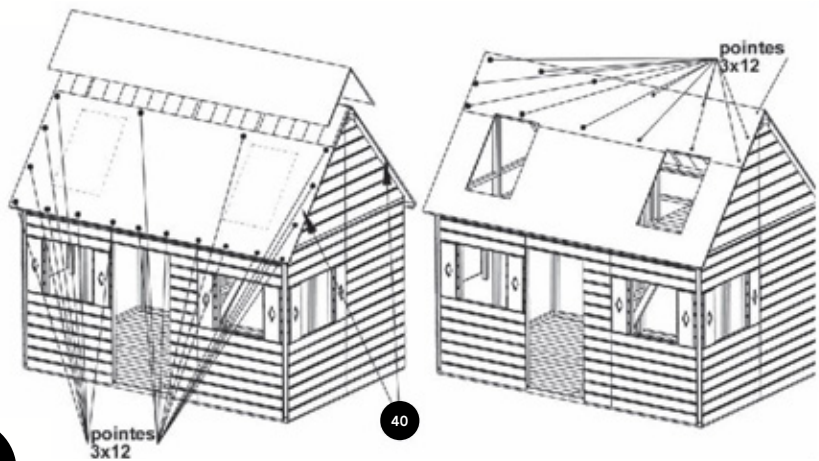

8

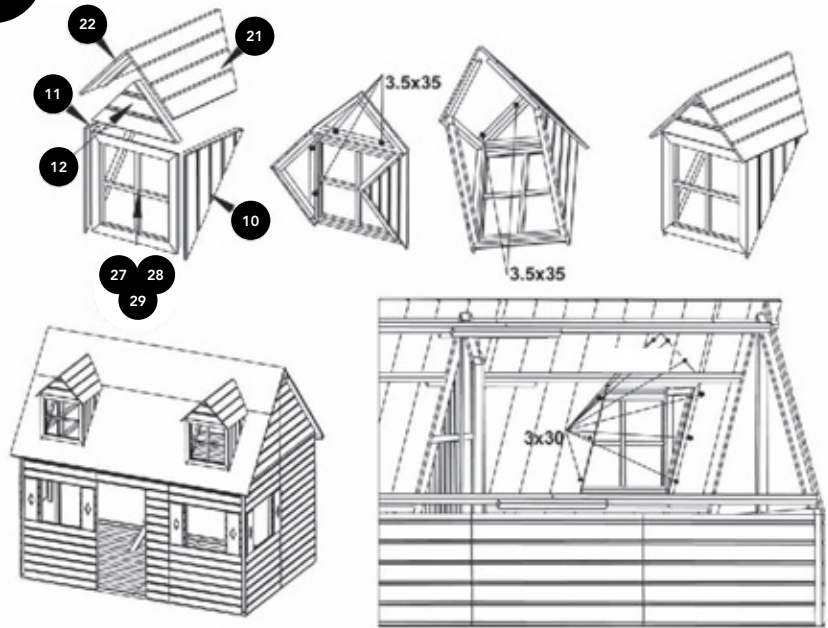

9

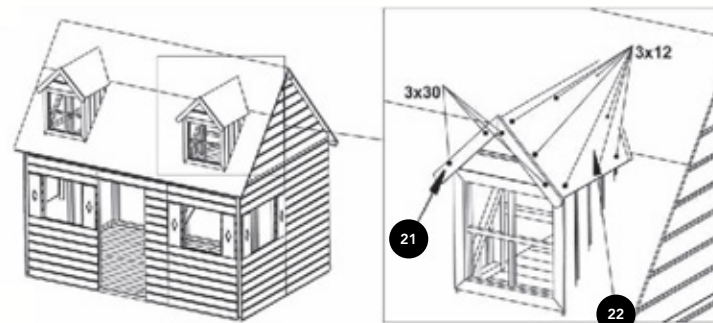

10

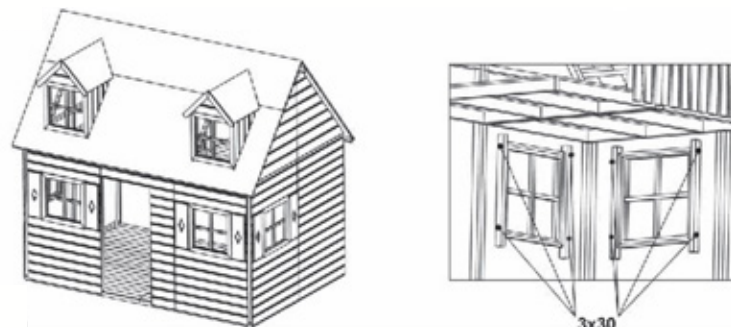

11

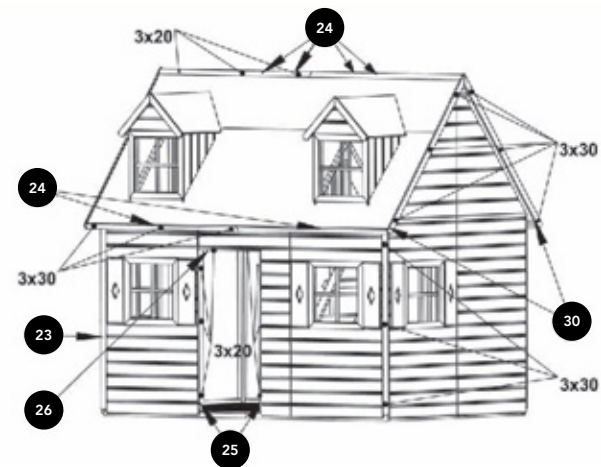

12

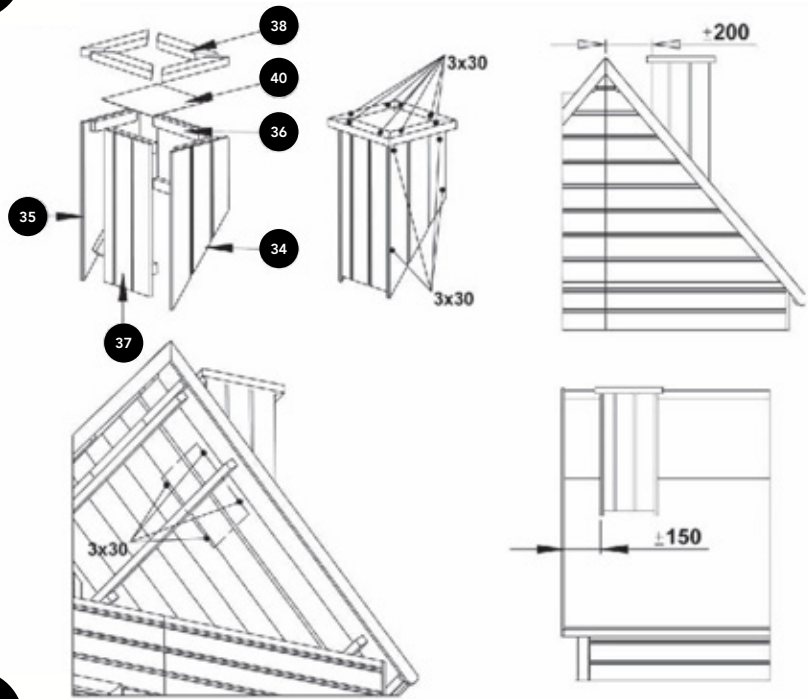

13

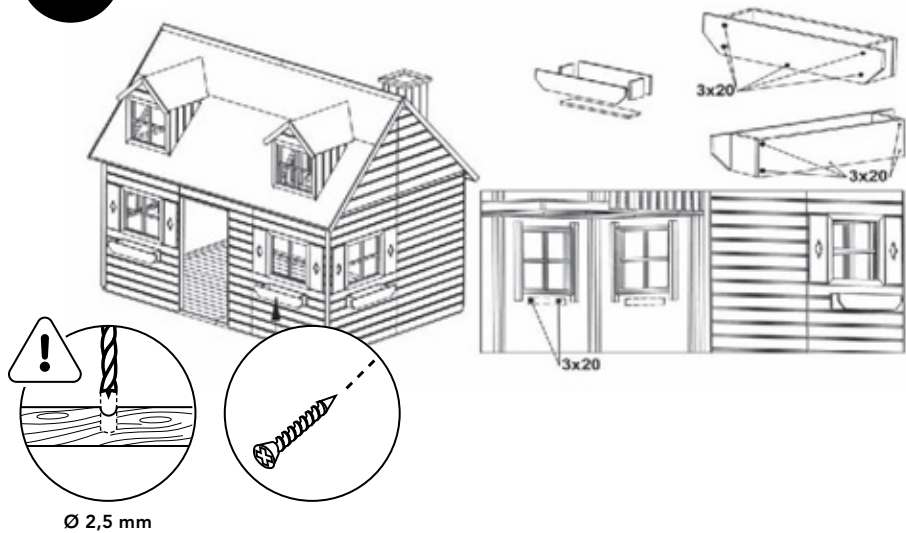

14

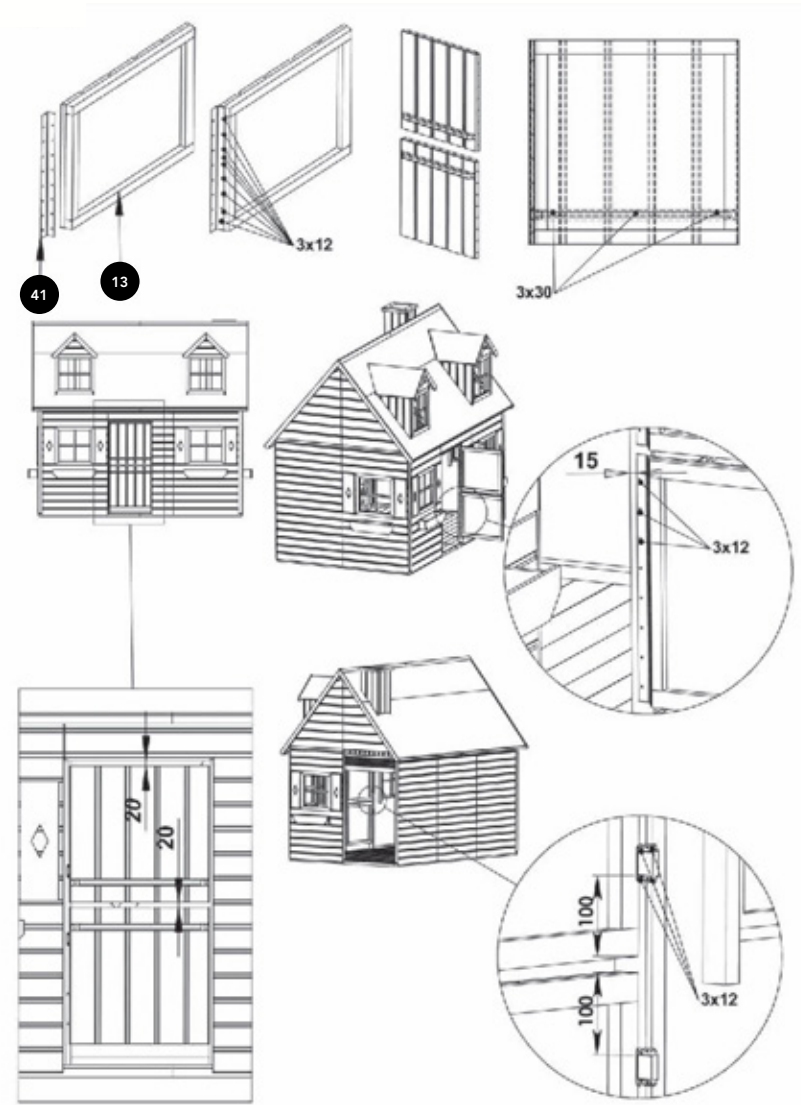

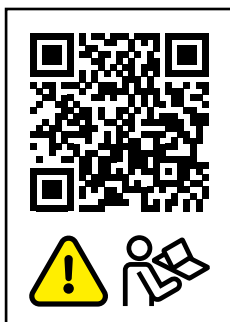

+31(0)318 692 221
www.swingking.nl

Swing King IS A BRAND OF:

HAPRO INTERNATIONAL

Morsestraat 6, 6716 AH Ede - The Netherlands

UK
CE



8 720701 430907 >